

ImmunoComb®

AVIAN *CHLAMYDOPHILA PSITTACI* ANTIBODY TEST KIT

INSTRUCTION MANUAL SUFFICIENT FOR 120 TESTS

I. INTENDED USE

This kit is designed to determine IgG antibody titers to *Chlamydomphila psittaci* (previously known as *Chlamydia psittaci*) in avian blood (or serum).

II. WHAT IS THE IMMUNOCOMB® ASSAY?

The ImmunoComb® is a self-contained portable kit. A sensitive test which detects antibody levels in blood or serum. The ImmunoComb® provides results within 60 minutes.

III. HOW DOES THE IMMUNOCOMB® WORK?

- Based on a solid phase immunoassay principle, the ImmunoComb® is a plastic card shaped like a comb, on which purified *Chlamydomphila psittaci* antigen is attached.
- Either immerse paper disks in avian blood or take a serum specimen. Deposit into sample well(s) of the multi-compartment developing plate (wells of Row A).
- Insert Comb into sample wells (in row A) so that antibodies from samples, if present, bind themselves to the antigens on the Comb.
- Non-bound antibodies are washed out in the second compartment.
- The next compartment contains an anti-avian IgG antibody labeled with an enzyme. Immerse the Comb in this "conjugate". The bound antibodies will be labeled.
- After 2 stages of washes, insert the Comb into the compartment where the enzyme reaction takes place. This generates a color change which indicates the amount of antibodies present.
- Using the CombScale, convert the lower spot color intensity to the anti-*Chlamydomphila psittaci* immunoglobulin level by comparing it to the positive reference which is located on the upper spot.
- The Comb may be divided to individual teeth. Each segment can be processed independently. Simply follow the Step-by-Step instructions.

IV. HANDLING & STORAGE

1. Store the kit under normal refrigeration: 2° - 8° C (36° - 46° F). **Do not freeze the kit.**
2. Before conducting the test, all kit elements and specimens must be at room temperature – preferably for 60 – 120 minutes (or 22 minutes at 37° C or 98.6° F). **Perform assay at room temperature of 20° - 25° C (68° - 77° F).**
3. Avoid spillage and cross-contamination of solutions.
4. Mix reagents by inverting developing plate several times prior to use.
5. Do not mix reagents from different kits or from different compartments of the same kit.
6. Do not touch teeth of ImmunoComb® card.

7. When using developing plate, pierce cover of each compartment by strictly following test procedure instructions. **Do not rip off or remove cover of entire developing plate all at once.**
8. The ImmunoComb® kit contains inactivated biological material. Kit must be handled and disposed of in accordance with accepted sanitary requirements.

V. READING & INTERPRETING THE RESULTS

- Read test results immediately.
- While reading this section refer to the example of a developed Comb and the table below.
- The upper spot (positive reference) should develop a readily visible grey color to confirm that the test has been processed correctly.
- The lower spot on the Comb is a *Chlamydomphila psittaci* spot.
- Optional scoring of results can be obtained by using the CombScale (refer to section VI).
- A white or a trace of grey color, scored as S<1, is considered a negative result.
- Any result scored as ≥ S3 indicates high antibody titer.
- A light grey color, scored as S=1-2, indicates low antibody titer that may not be significant in large psittacines.

Example of a Developed Comb

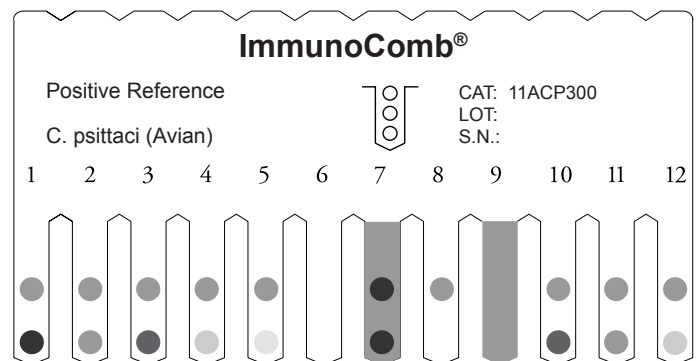

TOOTH No.	RESULT	REMARKS and SCORES ("S")
1, 3, 10	Dark grey	Positive
2, 11	Medium grey	Positive
4, 12	Light grey	Positive
5, 8	White	Negative
6	Both spots white	Invalid test
7	High background color with both spots in dark color.	Positive
9	High background color with no spots.	Invalid test

* Low antibody titers may not be significant in large psittacines.

The ImmunoComb® kit includes:

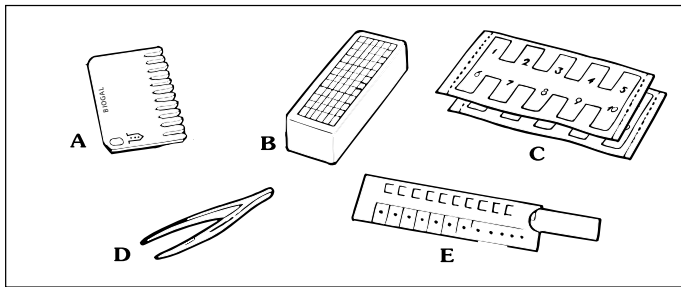

A. Ten Comb cards each wrapped in an aluminum envelope; B. Ten developing plates; C. Twelve specimen papers with pre-punched disks; D. One disposable tweezers; E. One CombScale color card; and a user manual.

Step-by-Step with the ImmunoComb®

Perform assay at room temperature of 20° - 25° C (68° - 77° F).

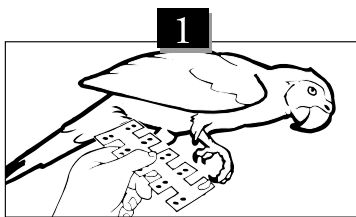

When using a paper disk, carefully cut one of the bird's toe nail. Take a specimen paper and saturate a pre-punched disk with the blood on **both sides** of the disk.

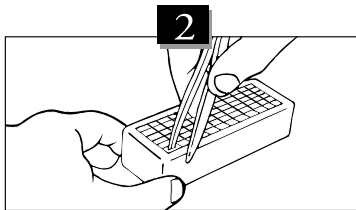

Slit open the protective aluminum covering of compartment A with the tweezers, one well for each sample.

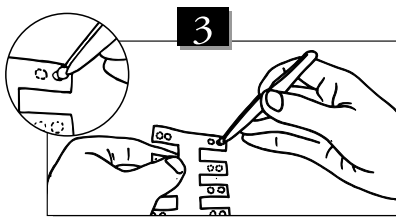

Punch out a disk saturated with blood.

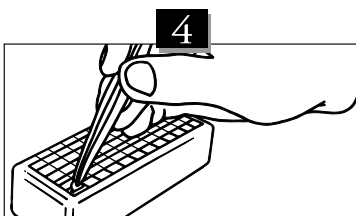

Insert the disk into well #1 of compartment A. Immerse it totally in the liquid reagent. Proceed with the other samples.

Incubate disk in well A for 60 minutes at room temperature to allow antibody extraction.

It is possible to use 5µl serum instead of whole blood disks. In this case deposit the sample by pipette into compartment A. Mix well! Proceed to step 5.

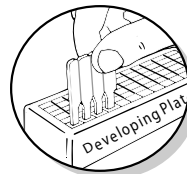

NOTE:

Remove the Comb from its protective wrapping. For testing less than 12 samples, cut or fold Comb in allocated notches for the number of tests required.

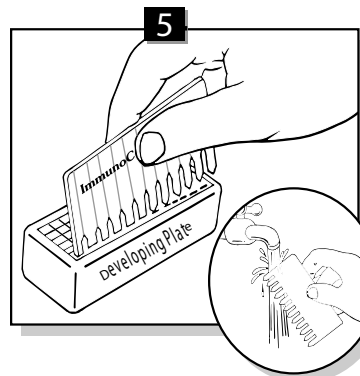

Insert the Comb into the open well(s) in **Row A** (printed side facing you). To improve mixing, gently jiggle the Comb up and down and then incubate in **Row A's** wells for **20 minutes**.

Pierce the cover of well(s) in **Row B** with the tweezers. Follow same procedure for remaining rows at end of each incubation period. Gently shake-off excess liquid onto a tissue. Wash both sides of the Comb for **5 seconds**, under clean cool tap water.

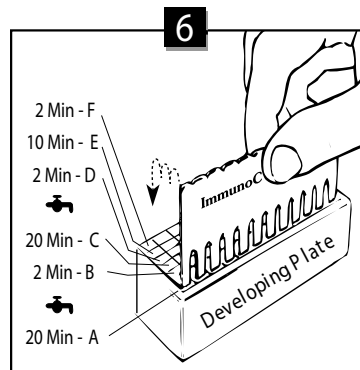

Insert Comb in well(s) of **Row B** and incubate for **2 minutes**. Transfer the Comb to well(s) in **Row C** and incubate for **20 minutes**. Wash under tap water and place in **Row D** for **2 minutes**. Shake-off. Transfer the Comb to **Row E** for **10 minutes**, allowing the color reaction process to develop. Shake it off again and insert in **Row F** for **2 minutes** for color fixation. Take the Comb out and let dry.

VI. READING RESULTS WITH THE COMBSCALE

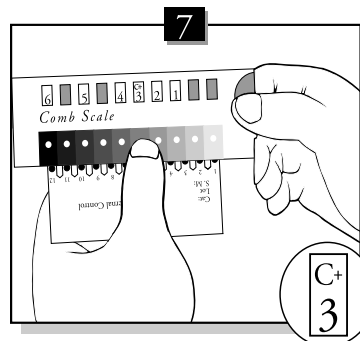

A. Match "C+" with the positive reference: When the Comb is completely dry, align it with the calibrated color CombScale. Compare the color resulting from the positive reference (upper spot) to the color scale by sliding the yellow ruler until the "C+" mark appears in the window corresponding to the color. Hold the slide in this position during reading and separately read each antigen-spot.

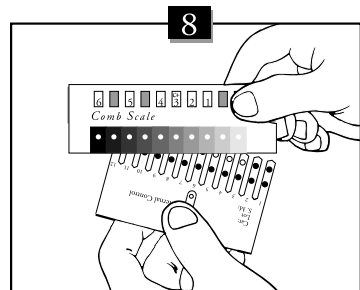

B. Match the color scale to the test result: Find the shade of grey on the CombScale that most closely matches the test result (lower spot). The number that appears in the window above is the Comb score.

Important! The margin of error is similar to that of other enzyme immunoassay kit procedures. Therefore, an error in one color scale window will not result in a wrong diagnosis.

Another way to read the results is by using the CombScan 2007. This is a software program that utilizes a computer and a twain compatible scanner. When a Comb is placed on the scanner, the program translates the color results into numerical values. The CombScan 2007 assists labs in reading ImmunoComb® results and conserving the data, and is supplied free of charge upon request.